

HIK***VISION***



Turret Network Camera

Quick Start Guide

COPYRIGHT © 2019 Hikvision. ALL RIGHTS RESERVED

Quick Start Guide

ALL RIGHTS RESERVED

Any and all information, including, among others, wordings, pictures, graphs are the properties of Hangzhou Hikvision Digital Technology Co., Ltd. or its subsidiaries (hereinafter referred to be “Hikvision”). This user manual (hereinafter referred to be “the Manual”) cannot be reproduced, changed, translated, or distributed, partially or wholly, by any means, without the prior written permission of Hikvision. Unless otherwise stipulated, Hikvision does not make any warranties, guarantees or representations, express or implied, regarding to the Manual.

About this Manual

This Manual is applicable to **Turret Network Camera**.

The Manual includes instructions for using and managing the product. Pictures, charts, images and all other information hereinafter are for description and explanation only. The information contained in the Manual is subject to change, without notice, due to firmware updates or other reasons. Please find the latest version in the company website (<http://overseas.hikvision.com/en/>).

Please use this user manual under the guidance of professionals.

Trademarks Acknowledgement

HIKVISION and other Hikvision’s trademarks and logos are the properties of Hikvision in various jurisdictions. Other trademarks and logos mentioned below are the properties of their respective owners.

Legal Disclaimer

TO THE MAXIMUM EXTENT PERMITTED BY APPLICABLE LAW, THE PRODUCT DESCRIBED, WITH ITS HARDWARE, SOFTWARE AND FIRMWARE, IS PROVIDED “AS IS”, WITH ALL FAULTS AND ERRORS, AND HIKVISION MAKES NO WARRANTIES, EXPRESS OR IMPLIED, INCLUDING WITHOUT LIMITATION, MERCHANTABILITY, SATISFACTORY QUALITY, FITNESS FOR A PARTICULAR PURPOSE, AND NON-INFRINGEMENT OF THIRD PARTY. IN NO EVENT WILL HIKVISION, ITS DIRECTORS, OFFICERS, EMPLOYEES, OR AGENTS BE LIABLE TO YOU FOR ANY SPECIAL, CONSEQUENTIAL, INCIDENTAL, OR INDIRECT

DAMAGES, INCLUDING, AMONG OTHERS, DAMAGES FOR LOSS OF BUSINESS PROFITS, BUSINESS INTERRUPTION, OR LOSS OF DATA OR DOCUMENTATION, IN CONNECTION WITH THE USE OF THIS PRODUCT, EVEN IF HIKVISION HAS BEEN ADVISED OF THE POSSIBILITY OF SUCH DAMAGES.

REGARDING TO THE PRODUCT WITH INTERNET ACCESS, THE USE OF PRODUCT SHALL BE WHOLLY AT YOUR OWN RISKS. HIKVISION SHALL NOT TAKE ANY RESPONSIBILITIES FOR ABNORMAL OPERATION, PRIVACY LEAKAGE OR OTHER DAMAGES RESULTING FROM CYBER ATTACK, HACKER ATTACK, VIRUS INSPECTION, OR OTHER INTERNET SECURITY RISKS; HOWEVER, HIKVISION WILL PROVIDE TIMELY TECHNICAL SUPPORT IF REQUIRED.

SURVEILLANCE LAWS VARY BY JURISDICTION. PLEASE CHECK ALL RELEVANT LAWS IN YOUR JURISDICTION BEFORE USING THIS PRODUCT IN ORDER TO ENSURE THAT YOUR USE CONFORMS THE APPLICABLE LAW. HIKVISION SHALL NOT BE LIABLE IN THE EVENT THAT THIS PRODUCT IS USED WITH ILLEGITIMATE PURPOSES.

IN THE EVENT OF ANY CONFLICTS BETWEEN THIS MANUAL AND THE APPLICABLE LAW, THE LATER PREVAILS.

Regulatory Information

FCC Information

Please take attention that changes or modification not expressly approved by the party responsible for compliance could void the user's authority to operate the equipment.

FCC compliance: This equipment has been tested and found to comply with the limits for a Class B digital device, pursuant to part 15 of the FCC Rules. These limits are designed to provide reasonable protection against harmful interference in a residential installation. This equipment generates, uses and can radiate radio frequency energy and, if not installed and used in accordance with the instructions, may cause harmful interference to radio communications. However, there is no guarantee that interference will not occur in a particular installation. If this equipment does cause harmful interference to radio or television reception, which can be determined by turning the equipment off and on, the user is encouraged to try to correct the interference by one or more of the following measures:

—Reorient or relocate the receiving antenna.

- Increase the separation between the equipment and receiver.
- Connect the equipment into an outlet on a circuit different from that to which the receiver is connected.
- Consult the dealer or an experienced radio/TV technician for help

FCC conditions

This device complies with part 15 of the FCC Rules. Operation is subject to the following two conditions:

1. This device may not cause harmful interference.
2. This device must accept any interference received, including interference that may cause undesired operation.

EU Conformity Statement



This product and - if applicable - the supplied accessories too are marked with "CE" and comply therefore with the applicable harmonized European standards listed under the the EMC Directive 2014/30/EU, the RoHS Directive 2011/65/EU.

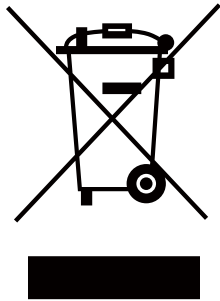

2012/19/EU (WEEE directive): Products marked with this symbol cannot be disposed of as unsorted municipal waste in the European Union. For proper recycling, return this product to your local supplier upon the purchase of equivalent new equipment, or dispose of it at designated collection points. For more information see: www.recyclethis.info

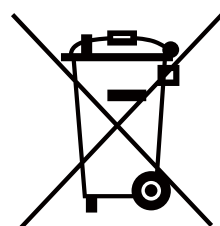

2006/66/EC and its amendment 2013/56/EU (battery directive): This product contains a battery that cannot be disposed of as unsorted municipal waste in the European Union. See the product documentation for specific battery information. The battery is marked with this symbol, which may include lettering to indicate cadmium (Cd), lead (Pb), or mercury (Hg). For proper recycling, return the battery to your supplier or to a designated collection point. For more information see: www.recyclethis.info.

Industry Canada ICES-003 Compliance

This device meets the CAN ICES-3 (B)/NMB-3(B) standards requirements.

Safety Instruction

These instructions are intended to ensure that the user can use the product correctly to avoid danger or property loss.

Laws and Regulations

The device should be used in compliance with local laws, electrical safety regulations, and fire prevention regulations.

Transportation

Keep the device in original or similar packaging while transporting it.

Power Supply

The input voltage should conform to IEC60950-1 standard: SELV (Safety Extra Low Voltage) and the Limited Power Source. Refer to the appropriate documentation for detailed information.

DO NOT connect multiple devices to one power adapter, to avoid over-heating or fire hazards caused by overload.

Make sure the plug is properly connected to the power socket.

System Security

The installer and user are responsible for password and security configuration and its settings.

Battery

Improper use or replacement of the battery may result in explosion hazard. Replace with the same or equivalent type only. Dispose of used batteries in conformance with the local codes.

L'utilisation ou le remplacement inadéquats de la pile peuvent entraîner un risque d'explosion. Remplacez-la par le même type ou l'équivalent du même type seulement. Jetez les piles usagées conformément aux directives fournies par le fabricant de la pile.

Maintenance

If the product does not work properly, please contact your dealer or the nearest service center. We shall not assume any responsibility for problems caused by unauthorized repair or maintenance.

A few device components (e.g., electrolytic capacitor) require regular replacement. The average lifespan varies, so periodic checking is recommended. Contact your dealer for details.

Cleaning

Please use a soft and dry cloth when clean inside and outside surfaces of the product cover. Do not use alkaline detergents.

Using Environment

When any laser equipment is in use, make sure that the device lens is not exposed to the laser beam, or it may burn out.

Do not expose the device to high electromagnetic radiation or dusty environments.

For indoor-only device, place it in a dry and well-ventilated environment.

Do not aim the lens at the sun or any other bright light.

Make sure the running environment meets the requirement of the device. The operating temperature shall be -30 °C to 60 °C (-22 °F to 140 °F), and the operating humidity shall be 95% or less (no condensing).

Do not place the camera in extremely hot, cold, dusty or damp locations, and do not expose it to high electromagnetic radiation.

Emergency

If smoke, odor, or noise arises from the device, immediately turn off the power, unplug the power cable, and contact the service center.

Time Synchronization

Set up camera time manually for the first time access if the local time is not synchronized with that of the network. Visit the camera via Web browser/client software and go to time settings interface.

Installation

Make sure the device is firmly secured to any wall or ceiling mountings.

Be sure that there is enough space to install the camera and accessories.

Make sure that the device in the package is in good condition and all the assembly parts are included.

Make sure that the wall is strong enough to withstand at least 4 times the weight of the camera and the mount.

The standard power supply is 12 VDC or PoE, please make sure your power supply matches with your camera.











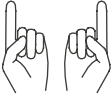

Make sure that the power has been disconnected before you wire, install, or disassemble the device.



Make sure that no reflective surface is too close to the camera lens. The IR light from the camera may reflect back into the lens causing reflection.



For device with this sticker, this device is intended for installation in a restricted access location, access can only be gained by service persons or by users who have been instructed about the reasons for the restrictions applied to the location and about any precautions that shall be taken.

Symbols and Marks

	Notice
	Warning
	Forbidden
	Correct
	Incorrect
	Turn to page A and continue.
	i. Not necessarily included accessory. ii. Variable accessory amount. iii. Skip this step if not required.
microSD 	MicroSD card
	Grounding
	Disposal
	Purchase separately
	Other situations

	Other situations omitted
	Waterproof
	Skip this step if not necessary

Installation

1.

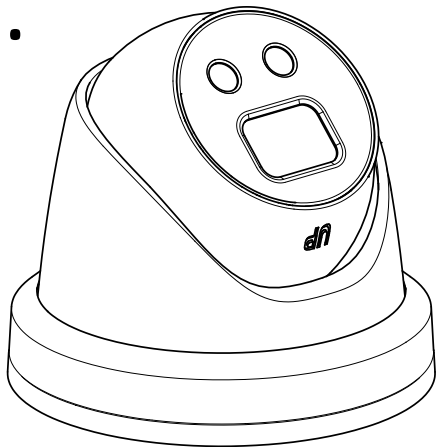

2.

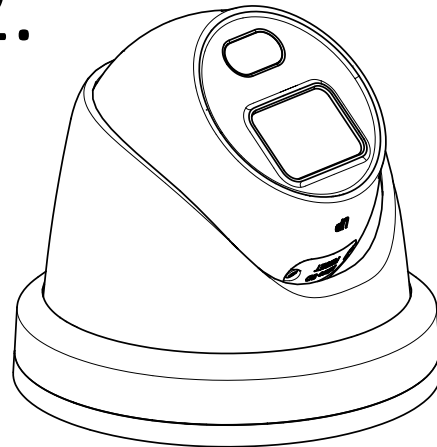

3.

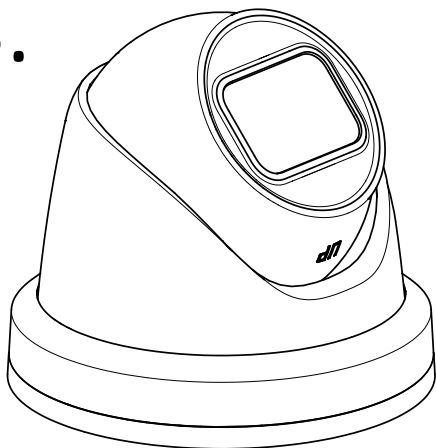

4.

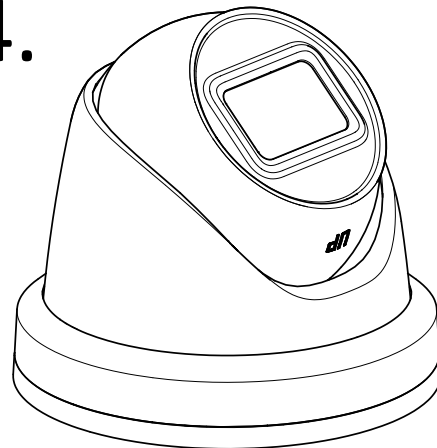

5.

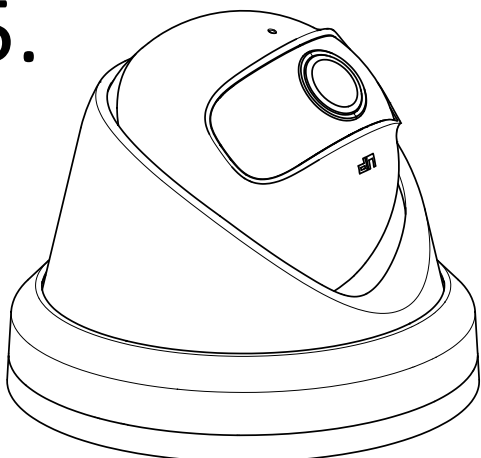

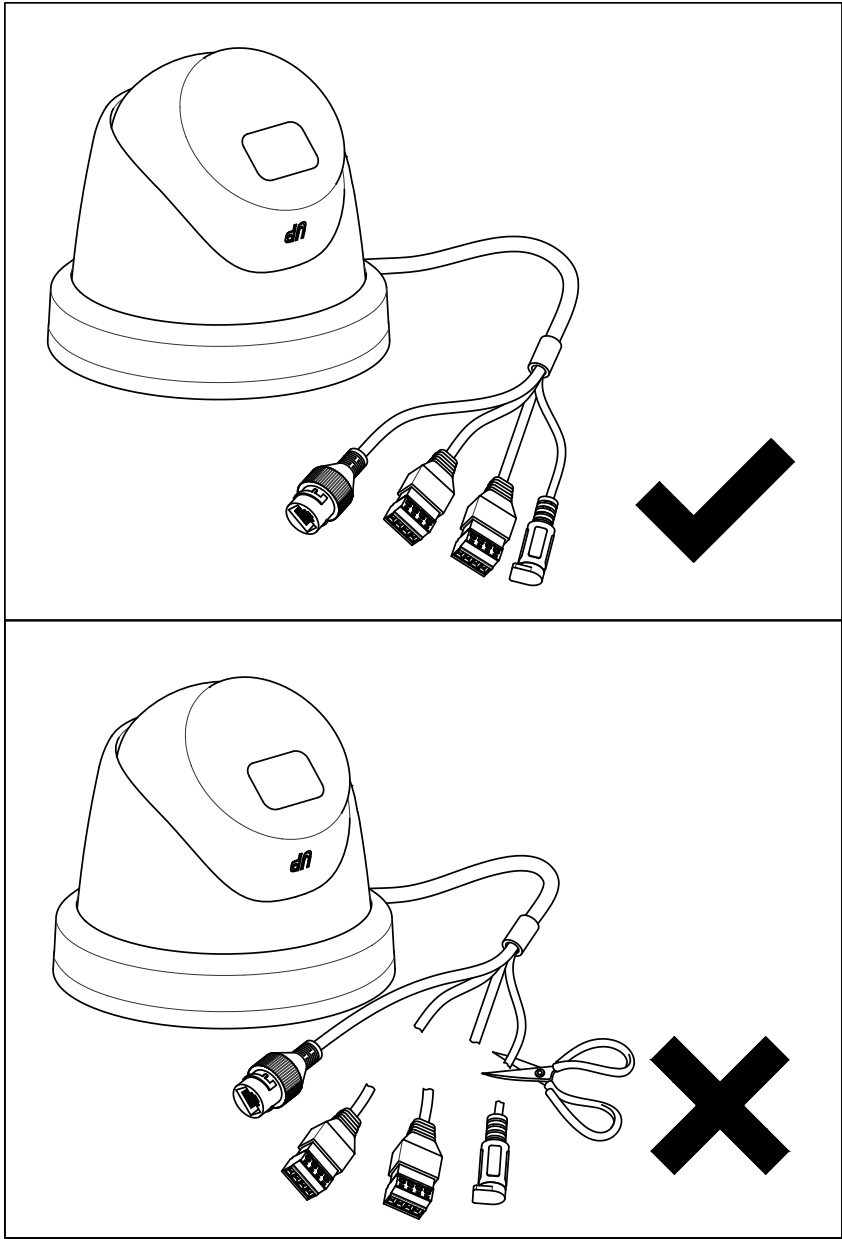

Installation

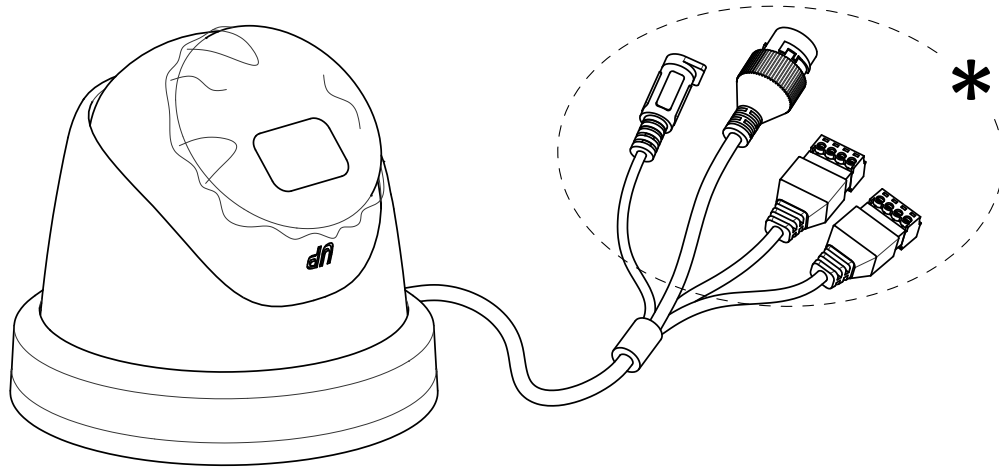

1x

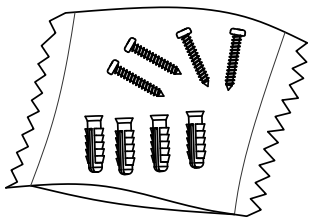

1x

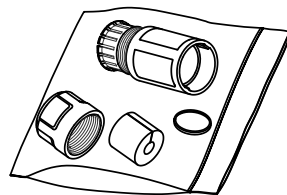

1x

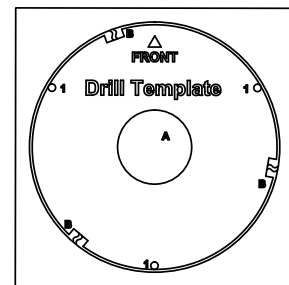

1x

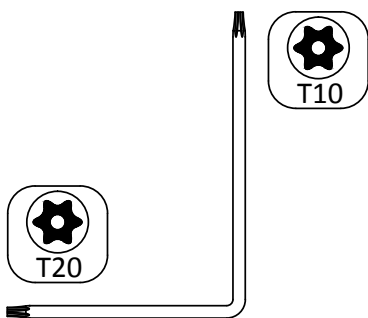

1x

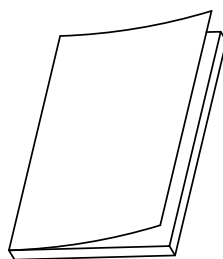

2x*

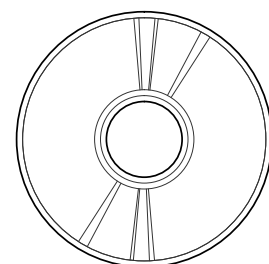

1x*

1.1

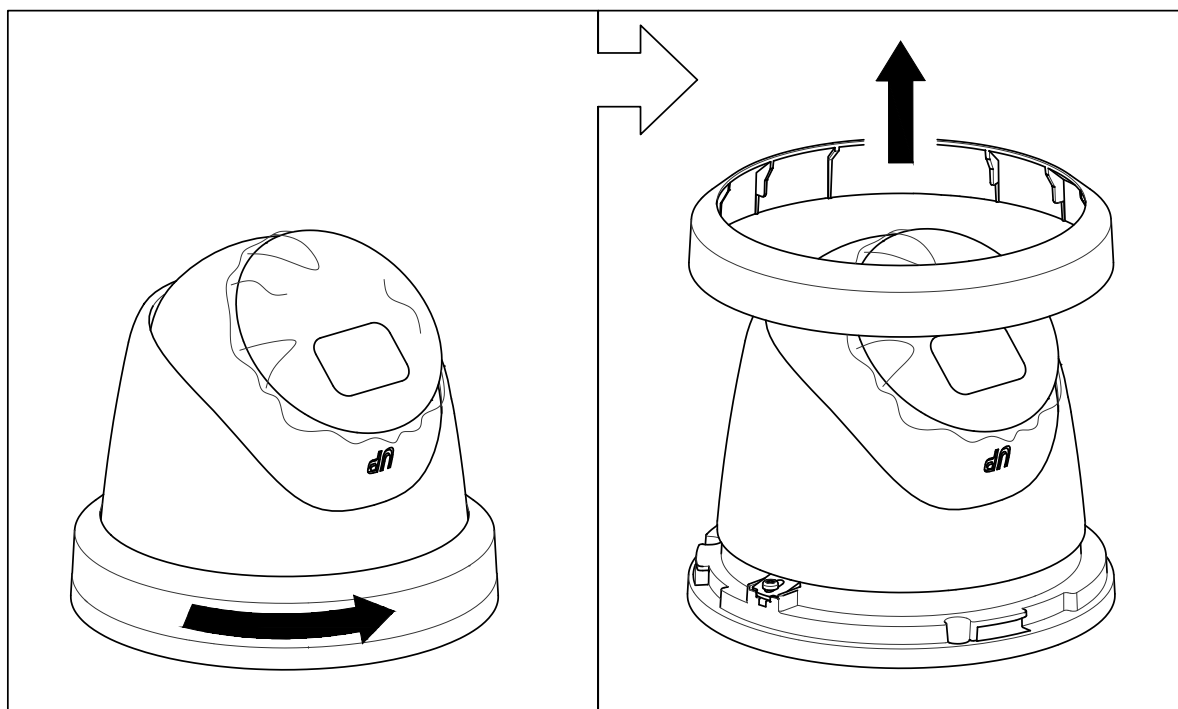

1.2

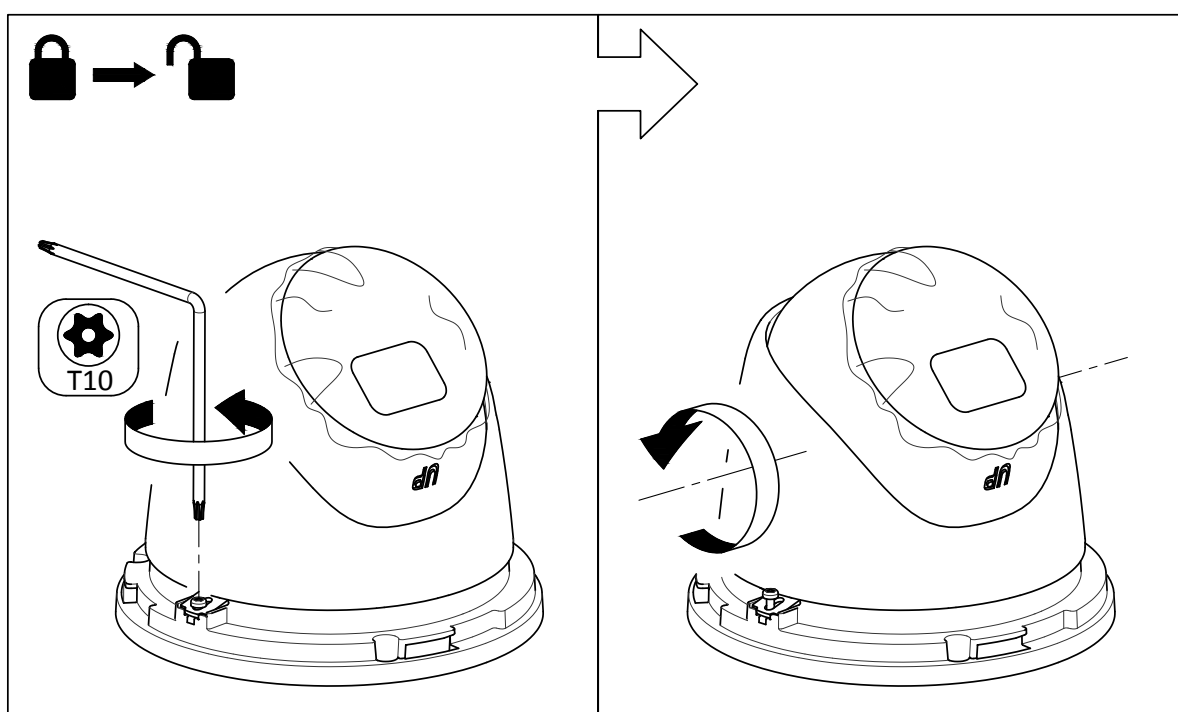

1.3*

microSD 

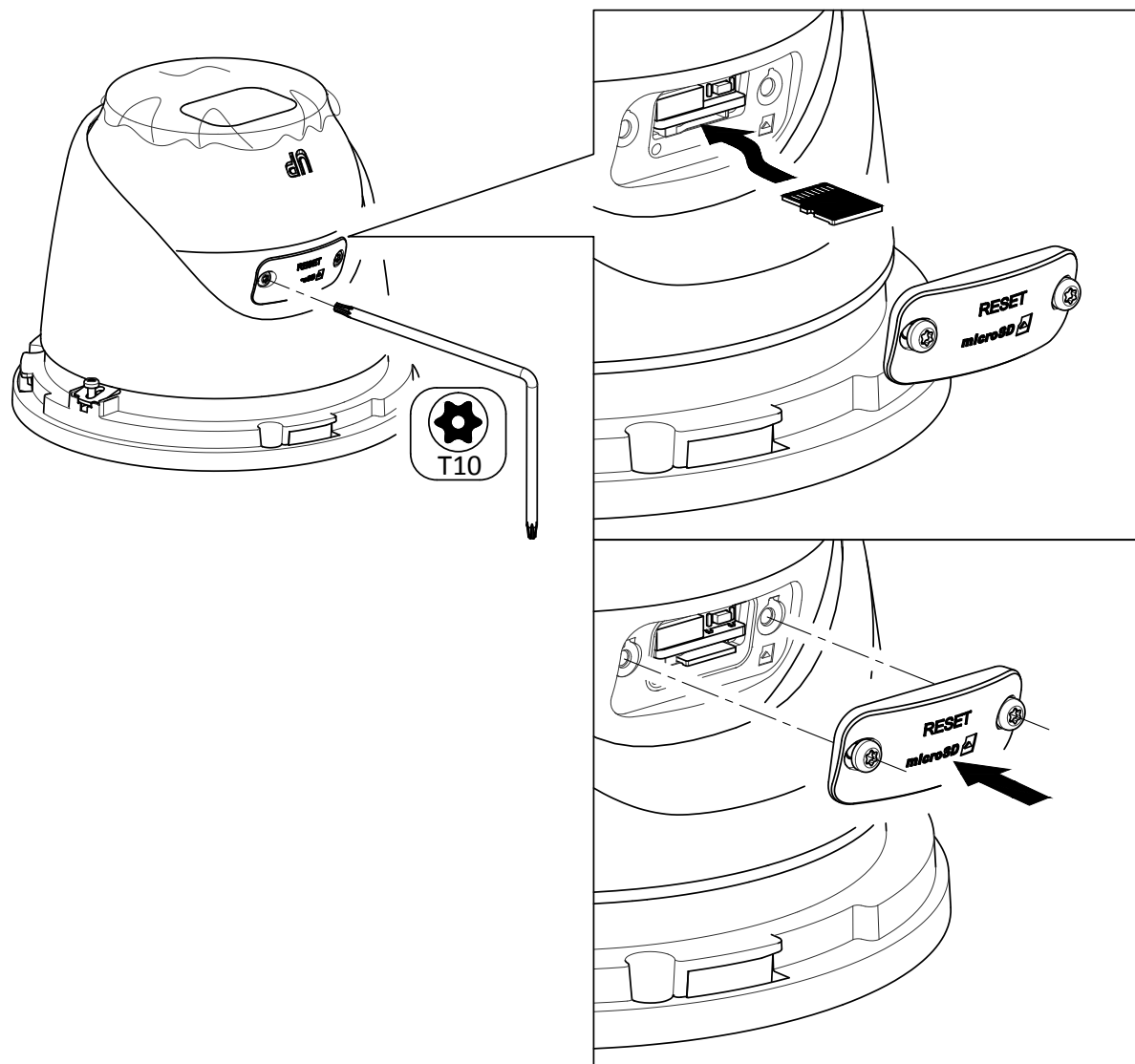

2.1

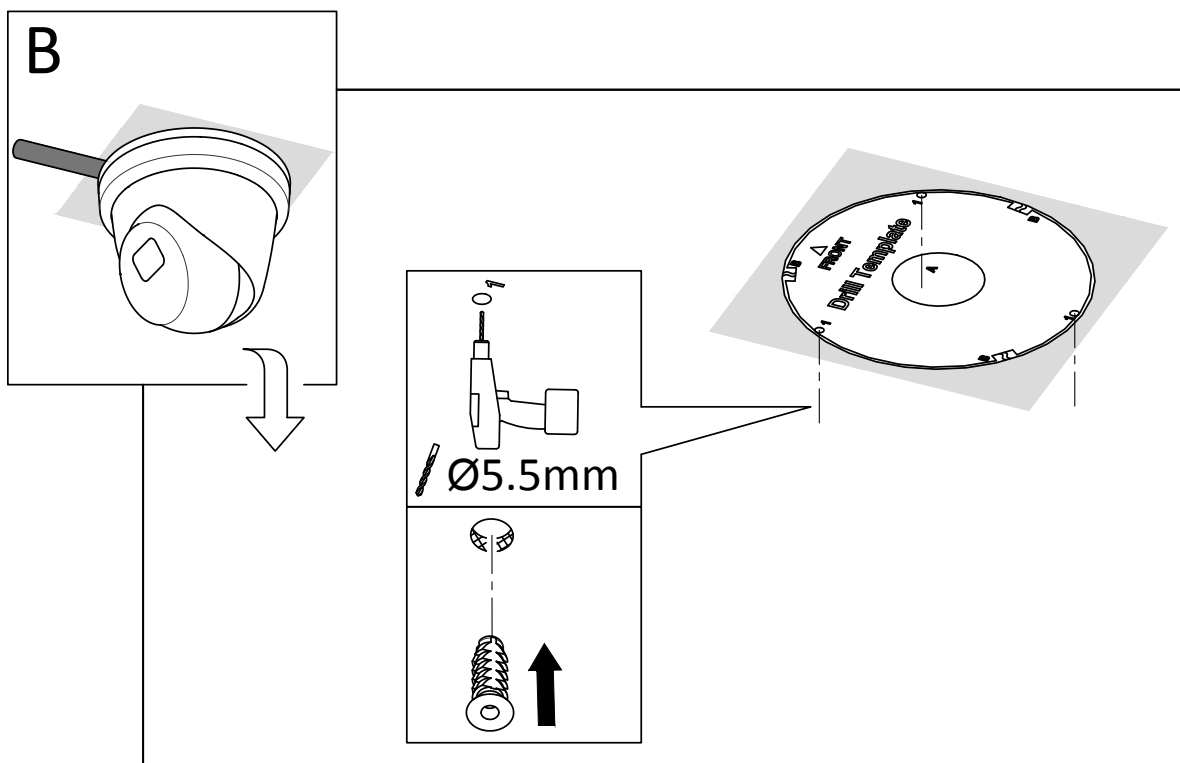
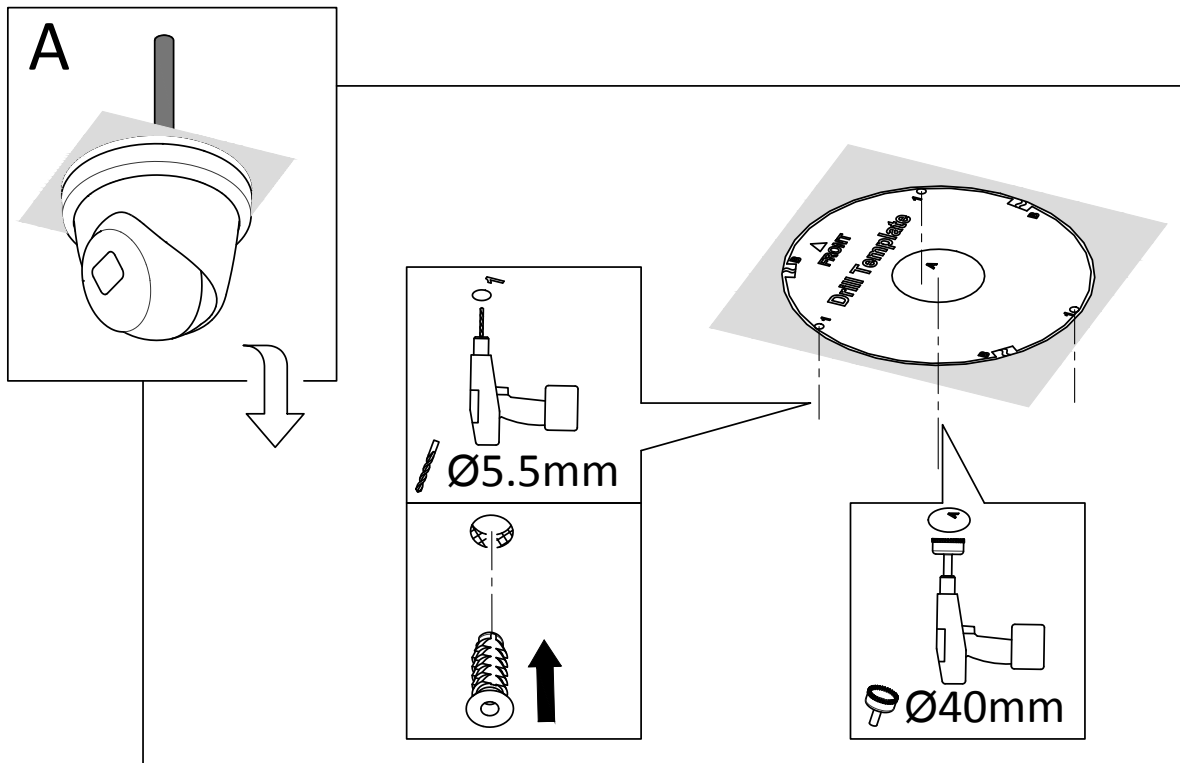

Installation

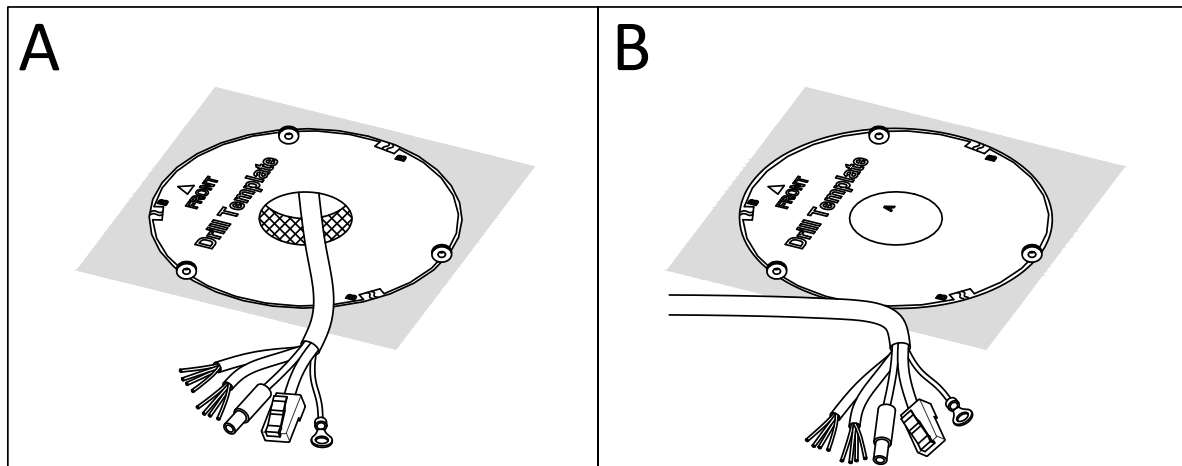

2.2

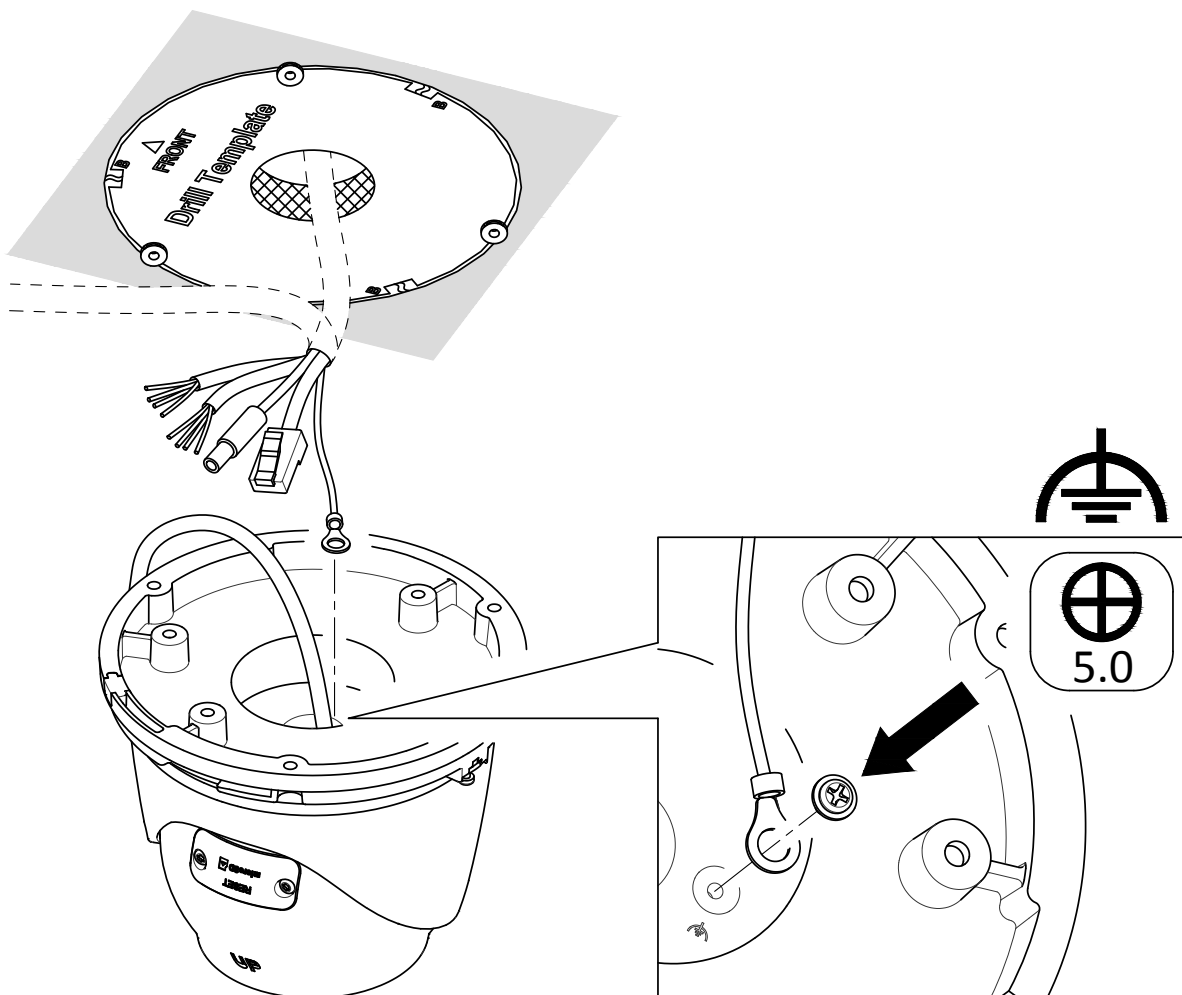

2.3

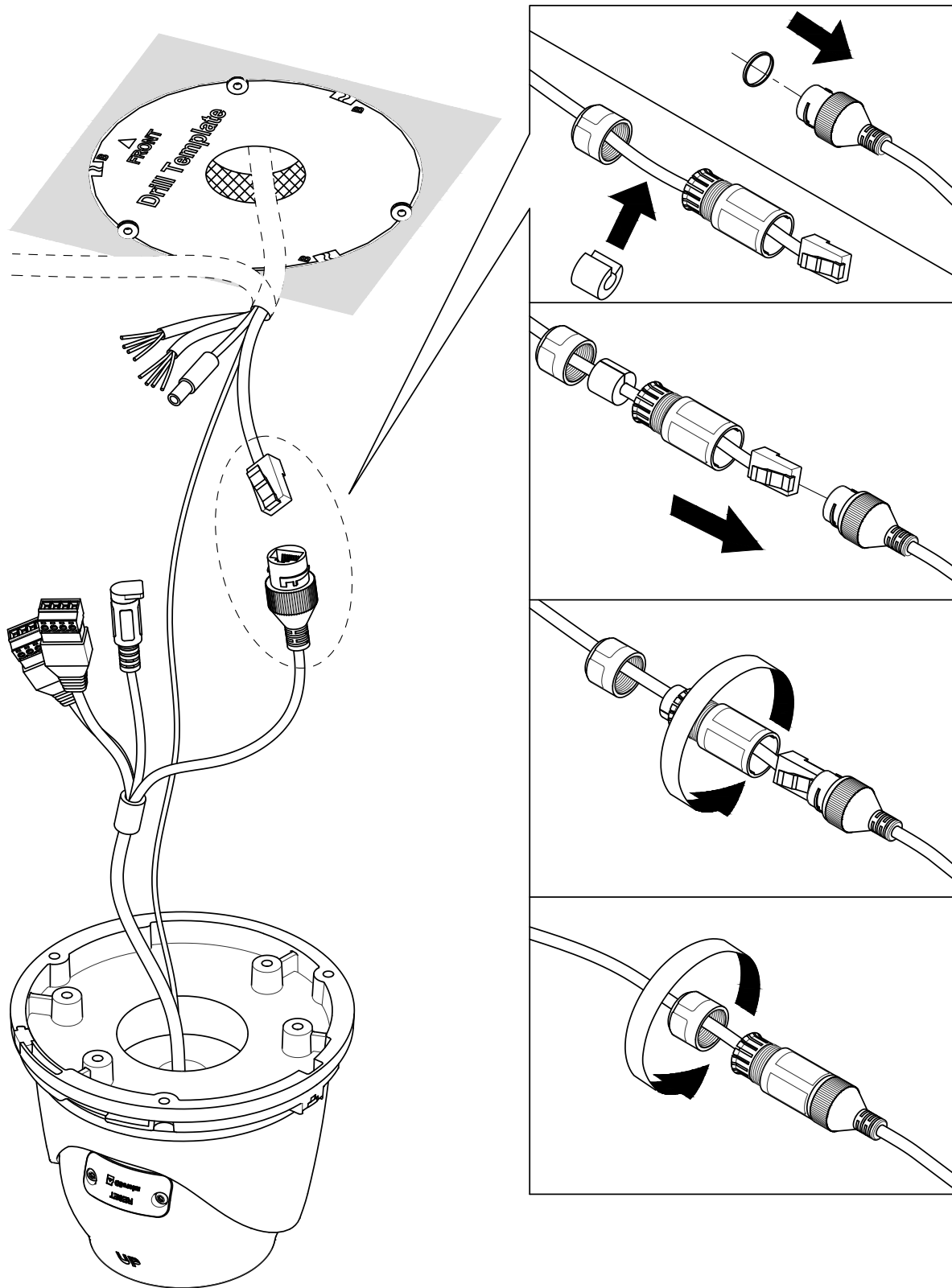

2.4

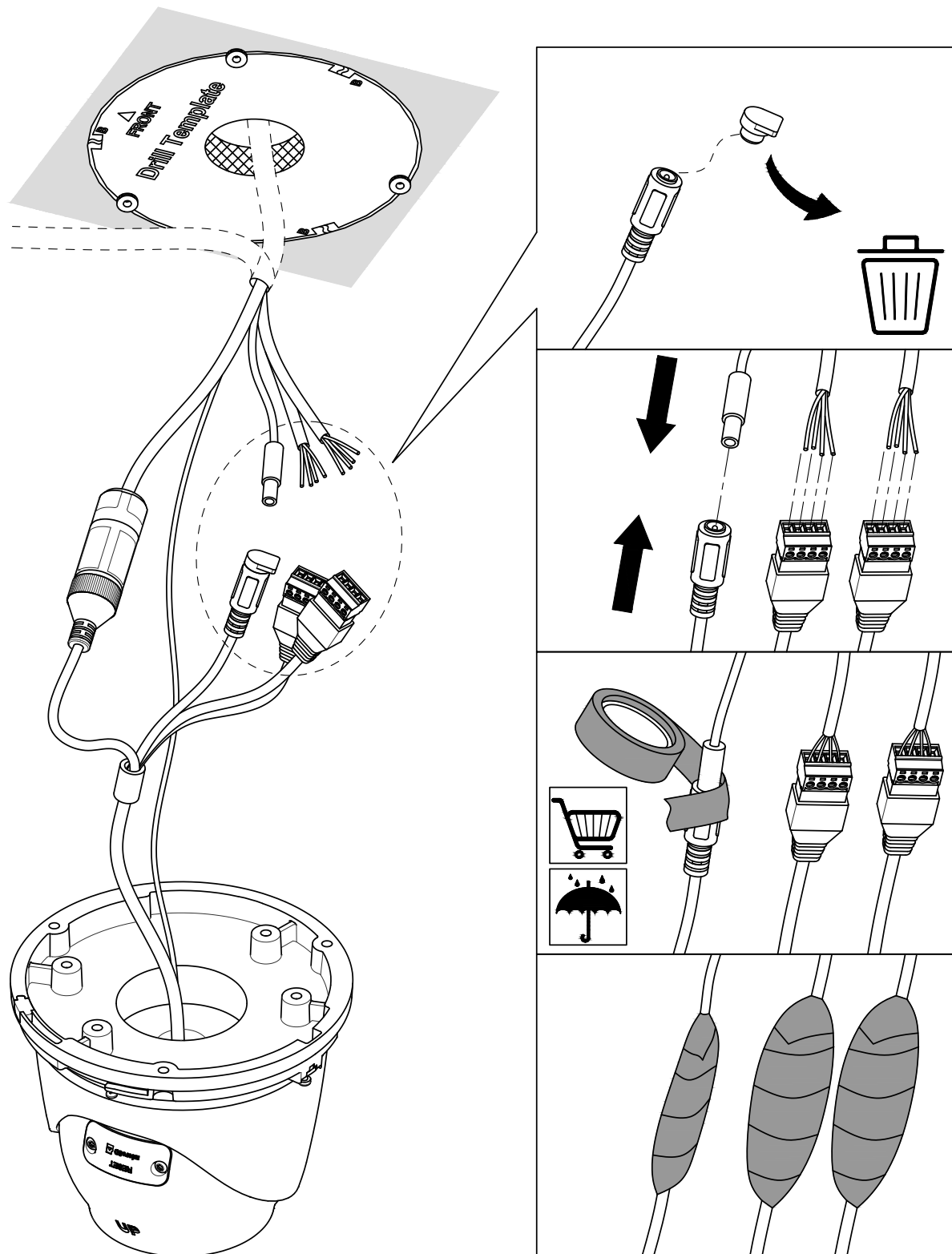

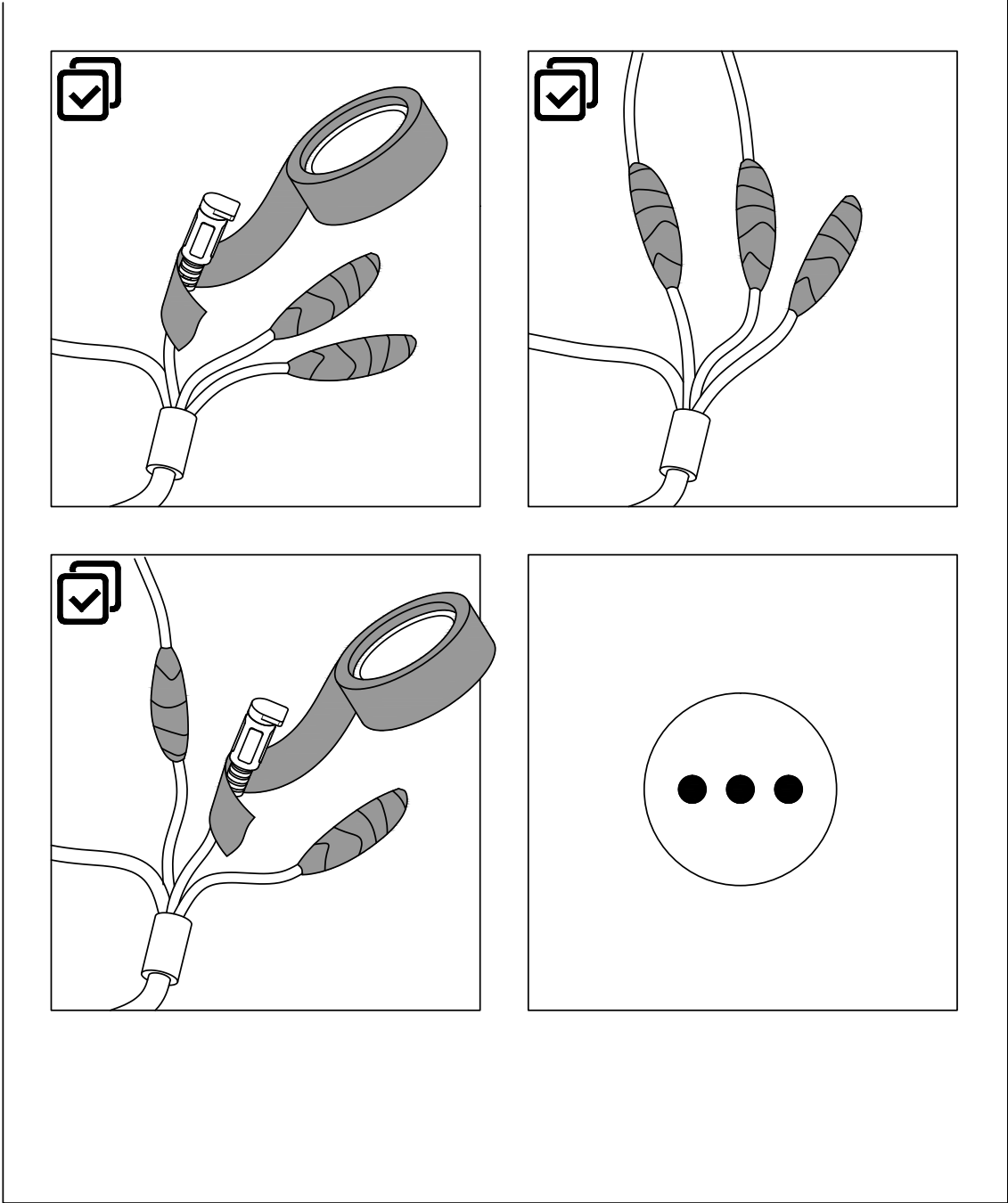

2.5

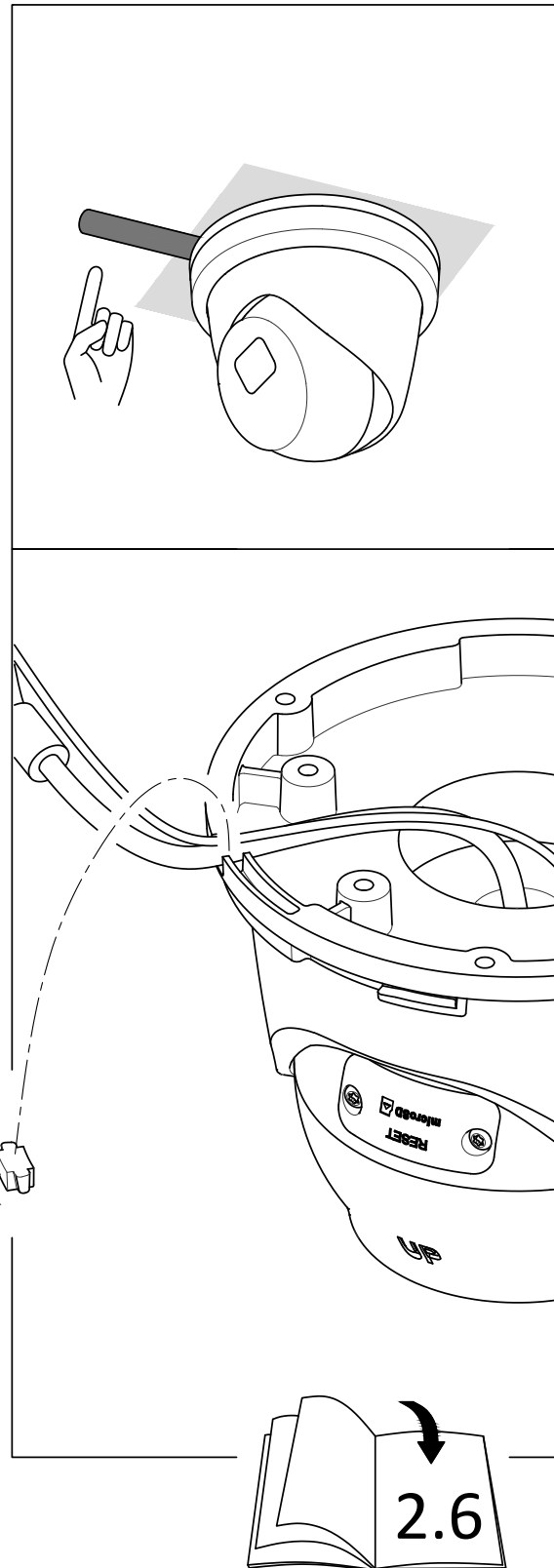
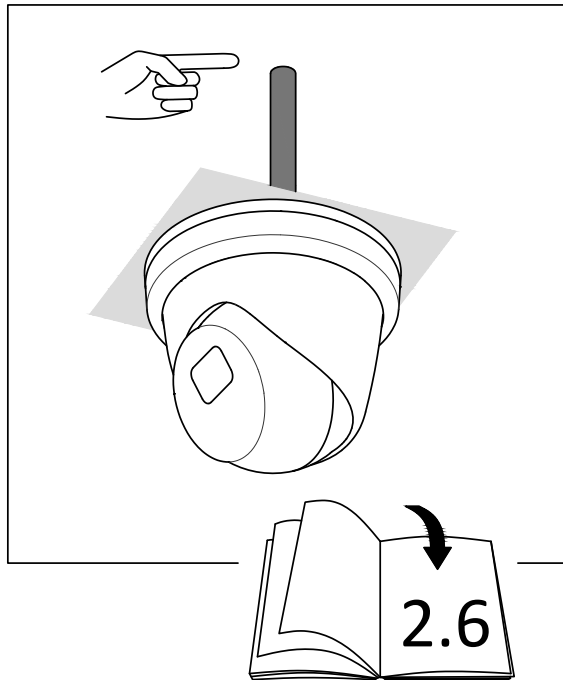

2.6

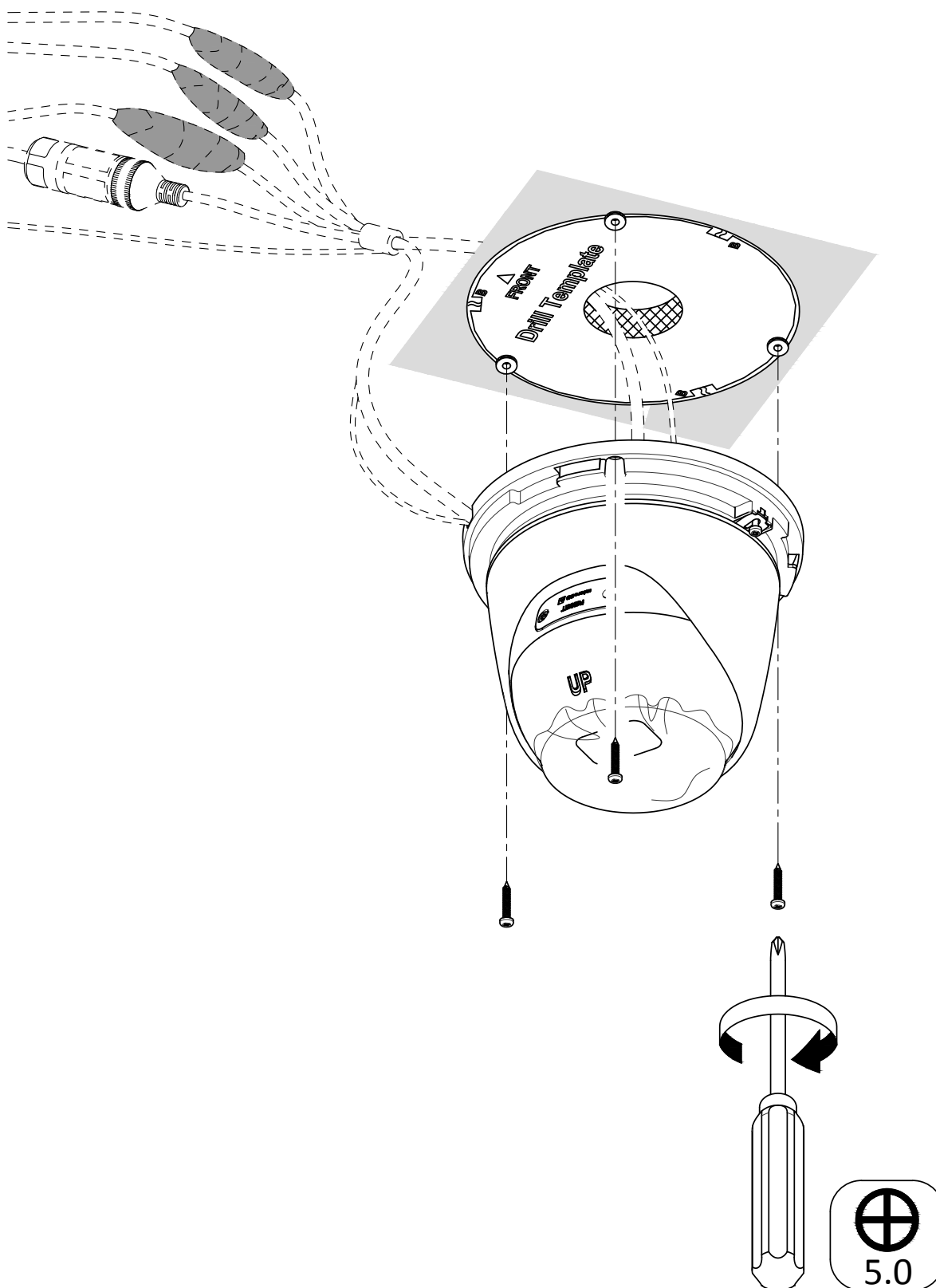

Installation

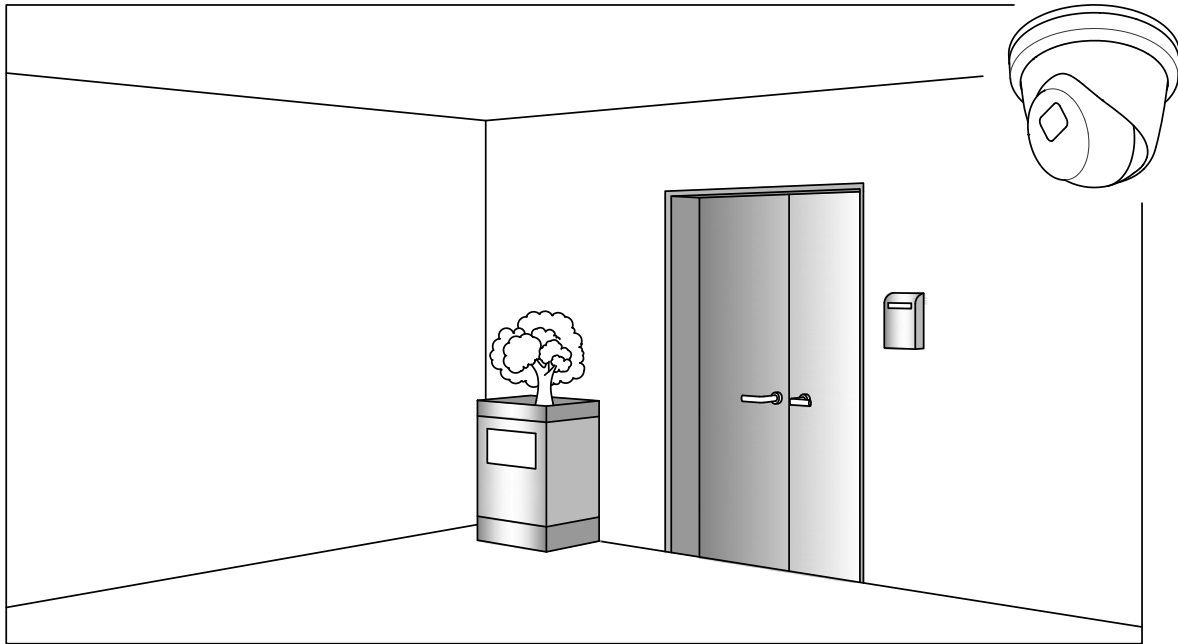

3.1

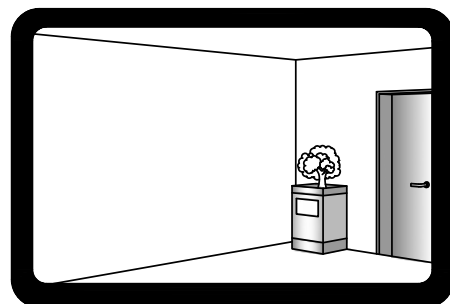
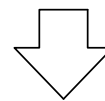
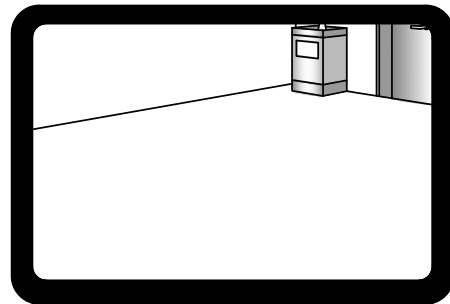
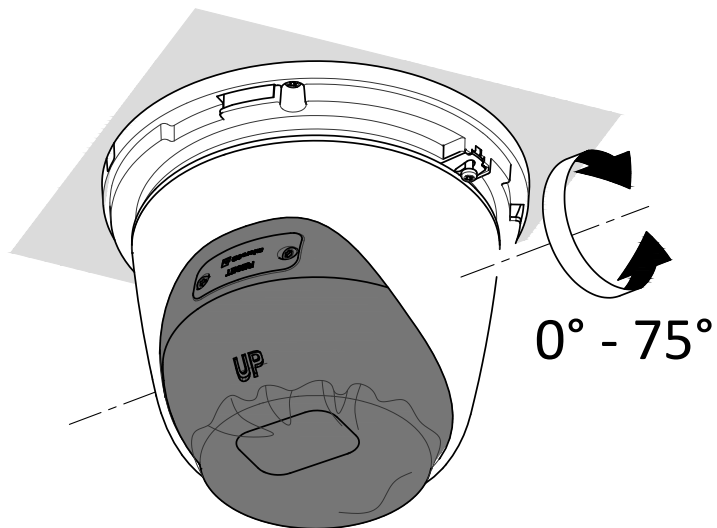

3.2

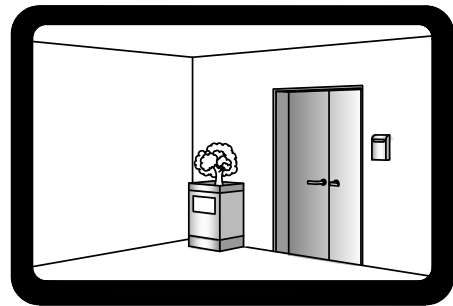
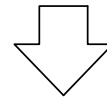
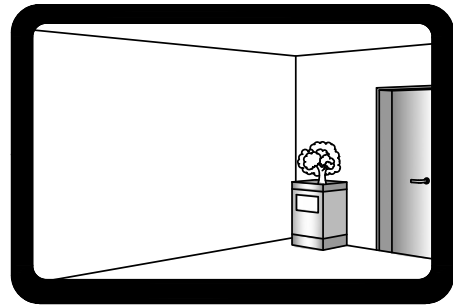
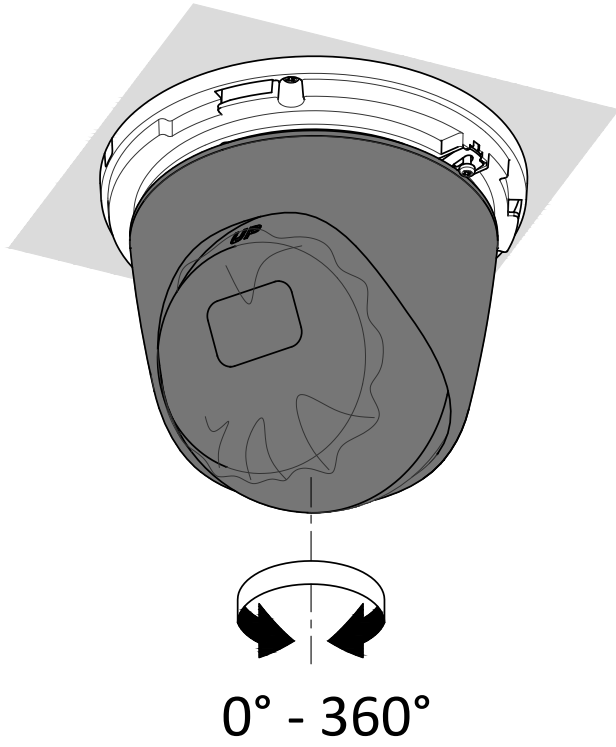

3.3

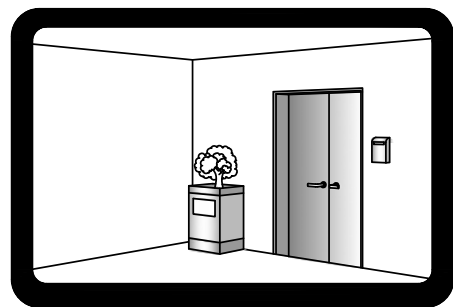
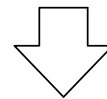
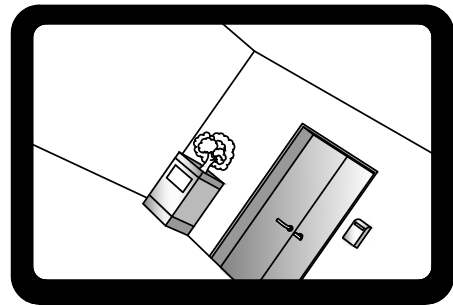
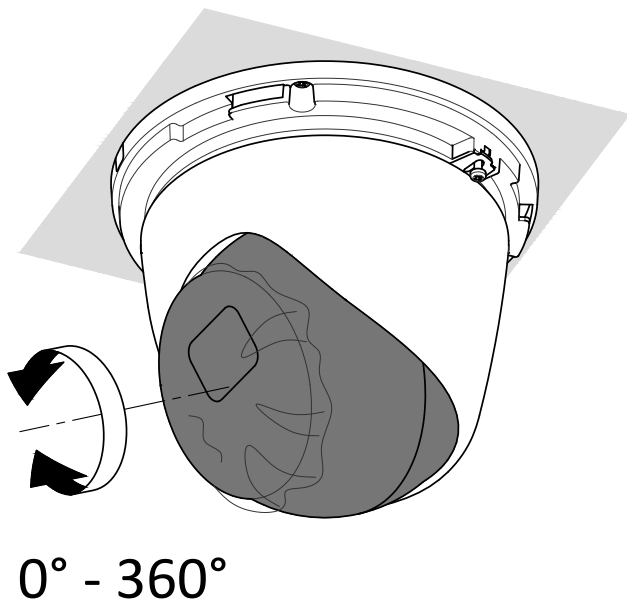

3.4

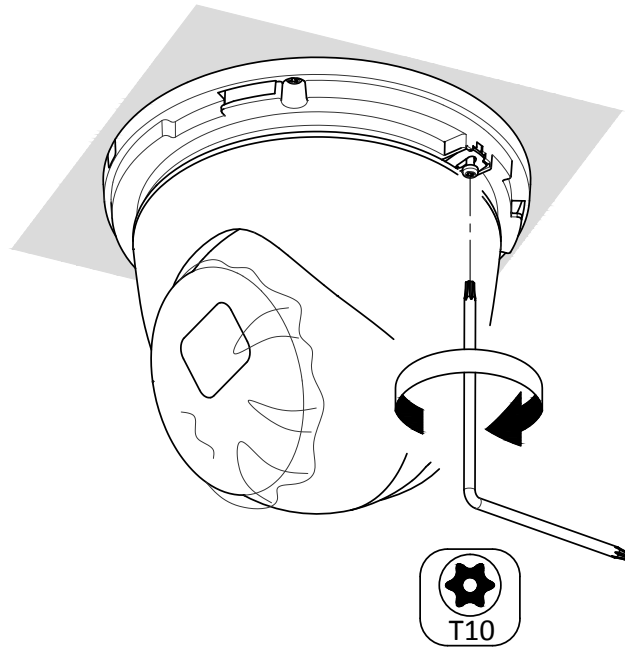

4.1

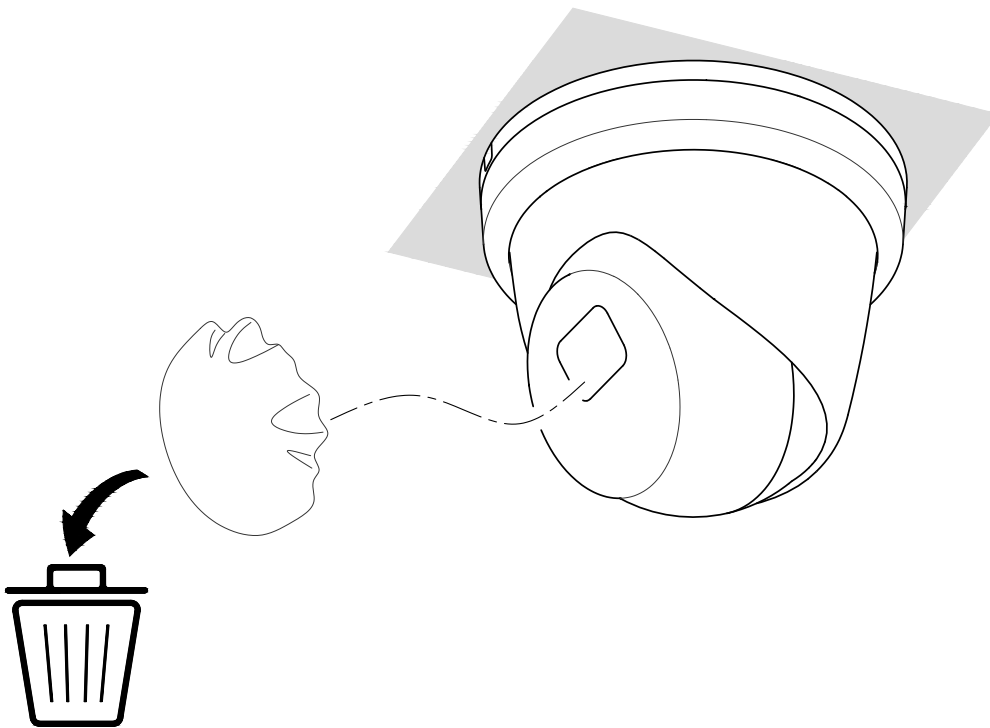
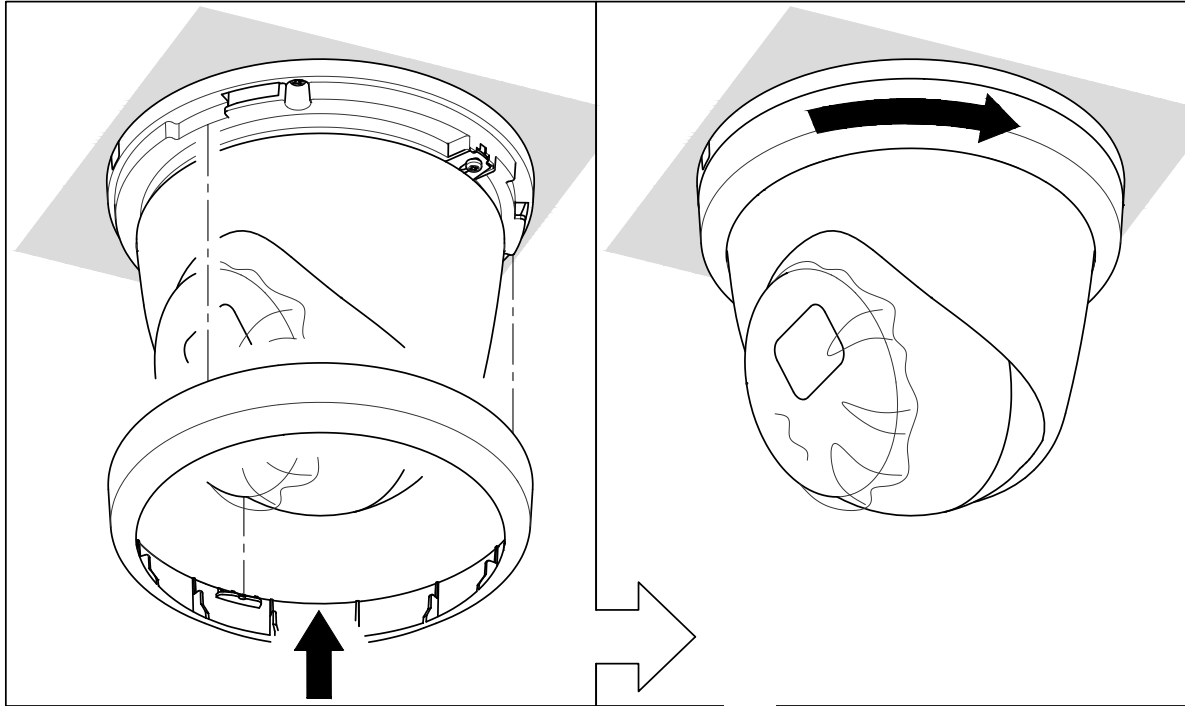

Installation

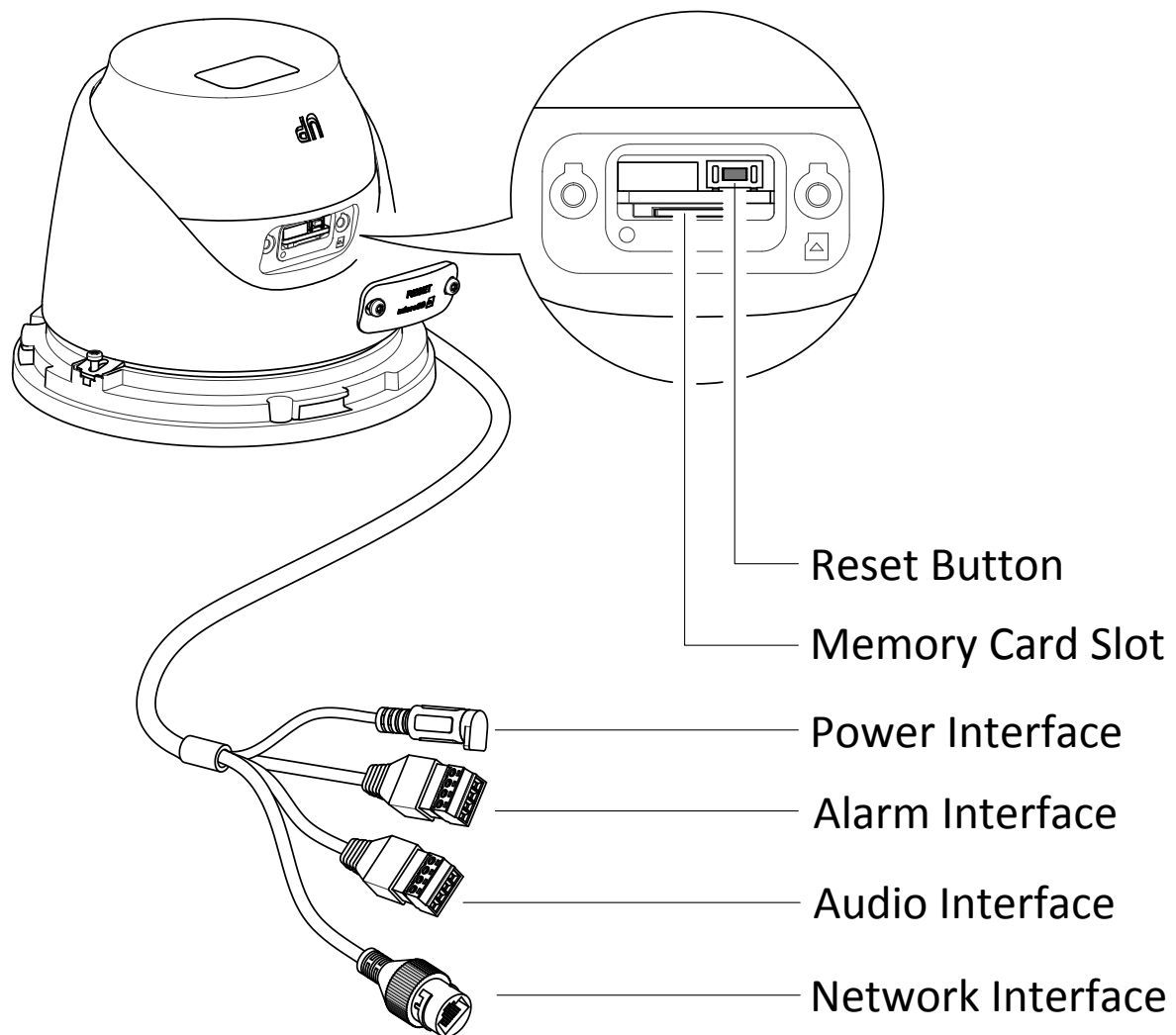

Activate and Access Network Camera

Scan the QR code to get *Activate and Access Camera*. Note that mobile data charges may apply if Wi-Fi is unavailable.



Reset and Restore Camera

Press **Reset** button for about 10s when the camera is powering on or rebooting to restore the default settings, including the user name, password, IP address, port No., etc.

For the position of the reset button, refer to the figure in the page 17.

